



# Grillo

AGRIGARDEN MACHINES



# GZ

## 120-123-220-223



GZ 120



GZ 223















GZ 223



GZ 123



GZ 220

		HP-kW	CC	 L (US qts)						 kg (lb)
<b>GZ 120</b>	RVM120 RATO	HP 2.7 - kW 2	120/1	0,8 (0.84)		155 rpm	--	A 28 cm (11 in)	52 cm (20 in)	35 (77)
<b>GZ 123</b>	GCV 170 Honda	HP 4.8 - kW 3.6	166/1	0,9 (0.95)		155 rpm	--	A 28 cm (11 in)	75 cm (29.5 in)	39 (86)
<b>GZ 220</b>	RVM120 RATO	HP 2.7 - kW 2	120/1	0,8 (0.84)		155 rpm	Max 2,1 km/h (1.3 mph)	A 28 cm (11 in)	52 cm (20 in)	41 (90)
<b>GZ 223</b>	GCV 170 Honda	HP 4.8 - kW 3.6	166/1	0,9 (0.95)		155 rpm	Max 2,1 km/h (1.3 mph)	A 28 cm (11 in)	75 cm (29.5 in)	45 (99)

# PRINCESS

## M1 - MR









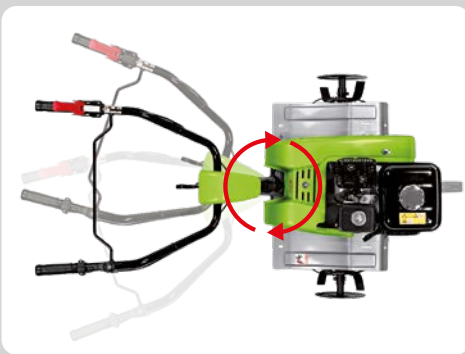



PRINCESS MR



PRINCESS M1



		HP-kW	CC	 L (US qts)						 kg (lb)
<b>M1</b>	G 200 FA Loncin	HP 5.5 - kW 4.1	196/1	3 (3.2)		① 132 rpm	--	A 32 cm (12 in)	30-52-77 cm (12-20-30 in)	62 (137)
<b>MR</b>	G 200 FA Loncin	HP 5.5 - kW 4.1	196/1	3 (3.2)		① 132 rpm	Max 2,3 km/h (1.4 mph)	A 32 cm (12 in)	30-52-77 cm (12-20-30 in)	64 (141)
	GX 200 Honda	HP 5.5 - kW 4.1	196/1	3,1 (3.3)						62 (137)

# PRINCESS

## MP3 - MP3 PRO



PRINCESS MP3



PRINCESS MP3 PRO

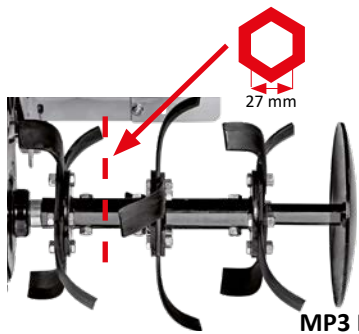

MP3 PRO



MP3



MP3 LABOUR KIT

		HP-kW	CC	 L (US qts)						 kg (lb)
<b>MP3</b>	G 200 FA Loncin	HP 5.5 - kW 4.1	196/1	3 (3.2)		Ⓛ 36 rpm Ⓜ 160 rpm	Max 2,3 km/h (1.4 mph)	A 32 cm (12 in)	30-52-77 cm (12-20-30 in)	65 (143)
<b>MP3 PRO</b>	G 200 FA Loncin	HP 5.5 - kW 4.1	196/1	3 (3.2)		Ⓛ 36 rpm Ⓜ 160 rpm	Max 2,3 km/h (1.4 mph)	A 32 cm (13 in)	56-82 cm (22-32 in)	68 (150)
	GX 200 Honda	HP 5.5 - kW 4.1	196/1	3,1 (3.3)		Ⓛ 36 rpm Ⓜ 160 rpm	Max 2,3 km/h (1.4 mph)	A 32 cm (13 in)	56-82 cm (22-32 in)	66 (145)

# HR7 PRO



HR78 PRO



HR78 PRO

















HR76 PRO



HR75 PRO



		HP-kW	CC/ 	 L (US qts)						 kg (lb)
HR75 PRO	G 200 FA Loncin	HP 5.5 - kW 4.1	196/1	 3 (3.2)		① 53 rpm ② 123 rpm ③ 162 rpm	Max 3 km/h (1.8 mph)	A 32 cm (12 in)	58-85-111 cm (23-33-43 in)	83 (183)
HR76 PRO	G 300 FA Loncin	HP 9.3 - kW 6.8	302/1	 6,1 (5.6)						95 (209.4)
HR77 PRO	SH178 FA Norwik	HP 5.3 - kW 4	306/1	Diesel  3,5 (3.6)						97 (213.8)
HR78 PRO	SH178 FA Norwik	HP 5.3 - kW 4	306/1	Diesel  3,5 (3.6)						105 (231.4)

# 11500

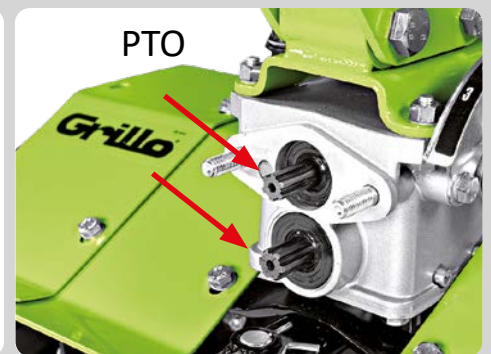
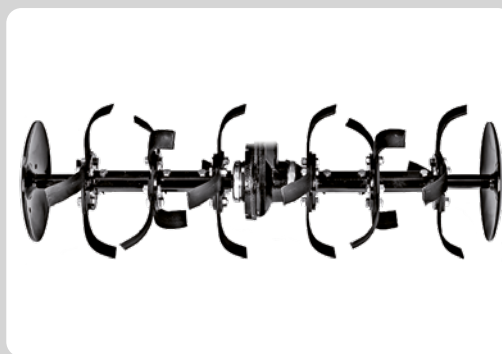





		HP-kW	CC/	 L (US qts)						 kg (lb)
11500	GX 200 Honda	HP 5.5 - kW 4.1	196/1	3,1 (3.3)						82 (180.7)
	GX 270 Honda	HP 8.4 - kW 6.3	270/1	5,3 (5.6)		① 53 rpm ② 123 rpm ③ 162 rpm	Max 3 km/h (1.8 mph)	A 34 cm (13.4 in)	59-86-112 cm (23-34-44 in)	90 (198.4) 98 (216)
	KD15 350 Kohler	HP 7.5 - kW 5.5	349/1	Diesel 4,3 (4.5)						121 (266.7)

# G 45

## COUNTER-ROTATING TILLER













										
<b>G 45</b>	G 200 FA Loncin	HP 5.5 - kW 4.1	196/1	3 (3.2) L (US qts)		 4.00-8 1,6 km/h (1 mph) →	 4.00-8 2,5 km/h (1.5 mph) ←	 A 26 cm (10 in)	50 cm (20 in)	82 (181) kg (lb)

# G 46

## COUNTER-ROTATING TILLER



										
<b>G 46</b>	GX 200 Honda	HP 5.5 - kW 4.1	196/1	3,1 (3.3)		 4.00-8 1,6 km/h (1 mph) →	 4.00-8 1,6 km/h (1 mph) ←	 A 26 cm (10 in)	 50 cm (20 in)	 98 (216)

# G 52



		HP-kW	CC	 L (US qts)					
<b>G 52</b>	G 200 FA Loncin	HP 5.5 - kW 4.1	196/1	3 (3.2)	13x5.00-6	13x5.00-6		A 26 cm (10 in)	67 (148)
					1,4 km/h (0.9 mph) →	2,2 km/h (1.4 mph) →			
					2,2 km/h (1.4 mph) ←	1,4 km/h (0.9 mph) ←			
								37-50 cm (15-20 in)	

# G 55



LABOUR KIT



		HP-kW	CC	 L (US qts)						 kg (lb)
<b>G 55</b>	G 200 FA Loncin	HP 5.5 - kW 4.1	196/1	 3 (3.2)		 4.00-8	 4.00-8	 A 26 cm (10 in)	 58 cm (23 in)	89 (196)
	GX 200 Honda	HP 5.5 - kW 4.1	196/1	 3,1 (3.3)		 I 1,1 km/h (0.7 mph) II 2,6 km/h (1.6 mph)	 I 1,1 km/h (0.7 mph) II 2,6 km/h (1.6 mph)			87 (192)

# G 84



## FORWARD AND COUNTER-ROTATING TILLER

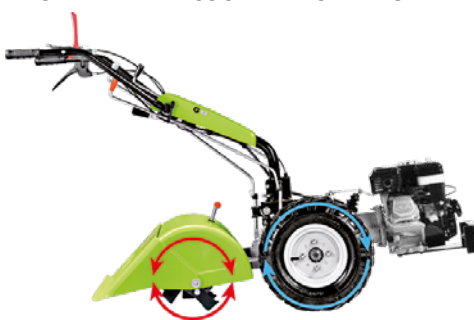

		HP-kW	CC	 L (US qts)						 kg (lb)
<b>G 84</b>	GX 200 Honda	HP 5.5 - kW 4.1	196/1	3,1 (3.3)		 4.00-8 ① 1,1 km/h (0.7 mph) ② 2,6 km/h (1.6 mph)	 4.00-8 ① 1,1 km/h (0.7 mph) ② 2,6 km/h (1.6 mph)	A 32 cm (12 in)	37-47-58 cm (15-19-23 in)	111 (245)

# G 85d

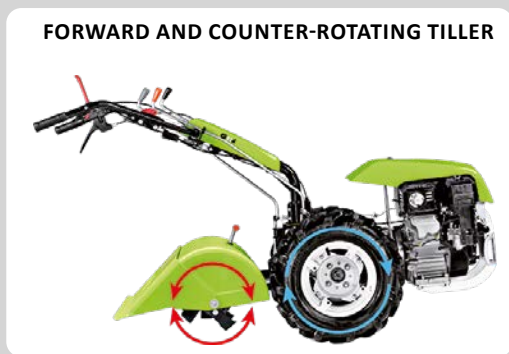

		HP-kW	CC	 L (US qts)		 DIFF. LOCK					 kg (lb)
<b>G 85d</b>	G 300 FA Loncin	HP 9.3 - kW 6.8	302/1	6,1 (6.4)		✓	4.00-10	4.00-10			127 (280)
	GX 270 Honda	HP 8.4 - kW 6.3	270/1	5,3 (5.6)		✓	⓪ 1,3 km/h (0.8 mph)	⓪ 1,3 km/h (0.8 mph)			127 (280)
	R 300 D Rato	HP 8.2 - kW 6	301/1	5,4 (5.7)		✓	⓪ 3,0 km/h (1.9 mph) ➔	⓪ 3,0 km/h (1.9 mph) ➔	A 32 cm (12 in)	37-47-58-68- 77 cm (15-19-23-27- 30 in)	142 (313)
	KD15 350 Kohler	HP 7.5 - kW 5.5	349/1	Diesel 4,3 (4.5)		✓	⓪ 1,3 km/h (0.8 mph) ⓪ 3,0 km/h (1.9 mph) ➔	⓪ 1,3 km/h (0.8 mph) ⓪ 3,0 km/h (1.9 mph) ➔			151 (332)

# G 107d



		HP-kW	CC	 L (US qts)		 DIFF. LOCK					 kg (lb)
<b>G 107d</b>	G 300 FA Loncin	HP 9.3 - kW 6.8	302/1	 6,1 (6.4)		✓	 5.00-10	 5.00-10			136 (300)
	GX 270 Honda	HP 8.4 - kW 6.3	270/1	 5,3 (5.6)		✓	 1,3 km/h (0.8 mph)  2,4 km/h (1.5 mph)  3,6 km/h (2.2 mph)	 1,3 km/h (0.8 mph)  2,4 km/h (1.5 mph)  3,6 km/h (2.2 mph)	A 32 cm (12 in)	37-47-58-68- 77 cm (15-19-23-27- 30 in)	136 (300)
	R 300 D Rato	HP 8.2 - kW 6	301/1	 5,4 (5.7)		✓	 1,3 km/h (0.8 mph)  2,4 km/h (1.5 mph)  3,6 km/h (2.2 mph)	 1,3 km/h (0.8 mph)  2,4 km/h (1.5 mph)  3,6 km/h (2.2 mph)			150 (330)
	KD15 440 Kohler	HP 11 - kW 8.1	441/1	Diesel  5 (5.3)		✓	 1,3 km/h (0.8 mph)  2,4 km/h (1.5 mph)  3,6 km/h (2.2 mph)	 1,3 km/h (0.8 mph)  2,4 km/h (1.5 mph)  3,6 km/h (2.2 mph)			168 (370)

# G 108 - G 110



































G 108



G 110



		 CC/HP HP-kW	 DIESEL L (US qts)		 Steering Brakes	 DIFF. LOCK					 kg (lb)
<b>G 108</b>	GX 270 Honda	270 cc/1 HP 8.4 - kW 6.3	 5,3 (5.6)		✓	✓	 5.00-10	 5.00-10			136 (300)
	GX 390 Honda	389 cc/1 HP 11.7 - kW 8.7	 6,1 (6.4)		✓	✓	 1,3 km/h (0.8 mph)  2,4 km/h (1.5 mph)  4,3 km/h (2.7 mph)	 1,3 km/h (0.8 mph)  2,4 km/h (1.5 mph)  4,3 km/h (2.7 mph)			144 (317)
<b>G 110</b>	KD15 440 Kohler	441 cc/1 HP 11 - kW 8.1	Diesel  5 (5.3)		✓	✓	 0,7 km/h (0.4 mph)  1,5 km/h (0.9 mph)  3,2 km/h (2.0 mph)	 0,7 km/h (0.4 mph)  1,5 km/h (0.9 mph)  3,2 km/h (2.0 mph)	 A 32 cm (12.6 in)	37-47-58-68- 77 cm (15-19-23-27- 30 in)	168 (370)

# G 131 - G 131 BC



G 131



G 131 BC



















G 131 BC



G 131 BC



G 131 BC

		HP-kW	CC/l	 L (US qts)		 DIFF. LOCK				 kg (lb)	
<b>G 131</b>	KD15 440 Kohler	HP11 - kW8.1	441 cc/1	Diesel 5 (5.3)		✓	 5.00-12	 5.00-12	 A 32 cm (12.6 in)	55-70-85 cm (22-28-34 in)	192 (423)
<b>G 131 BC</b>	Vanguard 16 B&S	HP 14 (16*) kW10.3	479/2	8,5 (8.9)		✓	 I 1,2 km/h (0.7 mph) II 2,4 km/h (1.5 mph) III 3,4 km/h (2.1 mph) IV 7,1 km/h (4.4 mph) →	 I 1,7 km/h (1.0 mph) II 3,5 km/h (2.2 mph) →	 A 32 cm (12.6 in)	55-70-85 cm (22-28-34 in)	195 (430)

\* Gross Power

# DUMPER

## 507- 406

















DUMPER 406



DUMPER 507









									
<b>Dumper 406</b>	G 210 FA Loncin	HP 6 - kW 4.4	212/1	3,6 (3.8)		I 1,0 km/h (0.6 mph) II 2,0 km/h (1.2 mph) III 3,5 km/h (2.2 mph)	I 1,0 km/h (0.6 mph) II 2,0 km/h (1.2 mph) III 3,5 km/h (2.2 mph)	400 kg (882 lb)	270 (595)
	GX 200 Honda	HP 5.5 - kW 4.1	196/1	3,1 (3.3)		I 1,0 km/h (0.6 mph) II 2,0 km/h (1.2 mph) III 3,5 km/h (2.2 mph)	I 1,0 km/h (0.6 mph) II 2,0 km/h (1.2 mph) III 3,5 km/h (2.2 mph)		268 (591)
<b>Dumper 507</b>	GX 270 Honda	HP 8.4 - kW 6.3	270/1	5,3 (5.6)		I 1,0 km/h (0.6 mph) II 2,0 km/h (1.2 mph) III 3,5 km/h (2.2 mph)	I 1,0 km/h (0.6 mph) II 2,0 km/h (1.2 mph) III 3,5 km/h (2.2 mph)	500 kg (1102 lb)	302 (666)
	R 300 D Rato	HP 8.2 - kW 6	301/1	5,4 (5.7)		I 1,0 km/h (0.6 mph) II 2,0 km/h (1.2 mph) III 3,5 km/h (2.2 mph)	I 1,0 km/h (0.6 mph) II 2,0 km/h (1.2 mph) III 3,5 km/h (2.2 mph)		319 (703)
	KD15 350 Kohler	HP 7.5 - kW 5.5	349/1	Diesel 4,3 (4.5)		I 1,0 km/h (0.6 mph) II 2,0 km/h (1.2 mph) III 3,5 km/h (2.2 mph) IV 8,7 km/h (5.4 mph)	I 1,0 km/h (0.6 mph) II 2,0 km/h (1.2 mph) III 3,5 km/h (2.2 mph)		337 (743)

# HWT 570











## MULTIFORCE



										
		HP-kW	CC	L (US qts)					kg (lb)	
<b>HWT 570 Multiforce</b>	GCV 170 Honda	HP 4.8 - kW 3.6	166/1	0,9 (0.95)		--	41 cm (16.2 in)	15-30-50-60 mm (0.6-1.2-2-2.4 in)	60 cm (24 in)	48 (105.8)

# HWT 600 WD













										
		HP-kW	CC	L (US qts)					kg (lb)	
<b>HWT 600 WD</b>	GCV 170 Honda	HP4.8 - kW3.6	166/1	0,9 (0.95)		2,5 km/h (1.5 mph)	41 cm (16.2 in)	15-30-50-60 mm (0.6-1.2-2-2.4 in)	60 cm (24 in)	47 (104)

# HWT 700









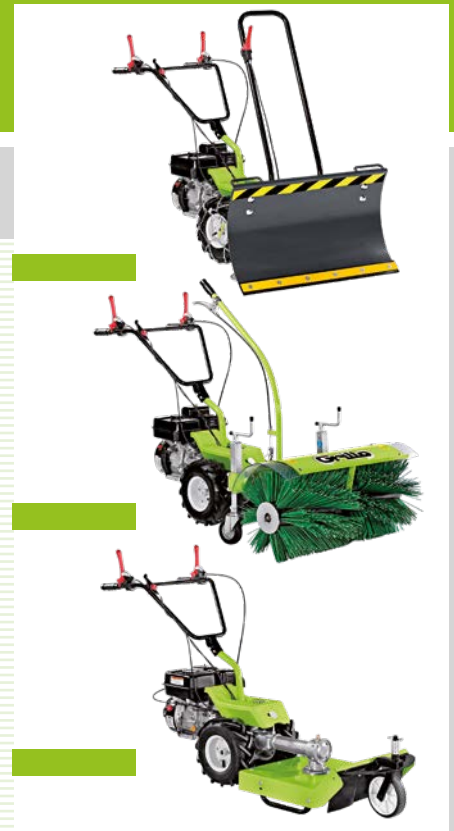

## SUPERTRAC



											
	HP-kW	CC	L (US qts)							kg (lb)	
<b>HWT 700 SUPERTRAC</b>	FJ180V KAI Kawasaki	HP4.5 - kW3.4	179/1	1,7 (1.5)		2,5 km/h (1.5 mph)	3.50-8	38 cm (14.9 in)	15-30-50-60 mm (0.6-1.2-2-2.4 in)	60 cm (24 in)	62 (137)





















# GF 1



										
<b>GF 1</b>	G 210 FA Loncin	HP 6-kW 4.4	212/1	3,6 (3.8) L (US qts)		13x5.00-6	2,20 km/h (1.4 mph)	-	86-96cm (34-38 in)	70 (154) kg (lb)

# GF 2































		HP-kW		 L (US qts)						 kg (lb)
GF 2	G 200 FA Loncin	HP 5.5 - kW 4.1	196/1				 4.00-8	 4.00-8	110-117 cm (43-46 in)	98 (216)
	GX 200 Honda	HP 5.5 - kW 4.1	196/1				 1,0 km/h (0.6 mph)  2,0 km/h (1.2 mph)  3,0 km/h (1.9 mph)	 1,0 km/h (0.6 mph)  2,0 km/h (1.2 mph)  3,0 km/h (1.9 mph)		96 (212)

# GF 3 - GF 3DF













GF 3DF



		HP-kW		 L (US qts)							
GF 3	G 300 FA Loncin	HP 9.3 - kW 6.8	302/1	6,1 (6.4)		-	-			110-117 127-132-137 cm (43-46-50-52- 54 in)	105 (231)
	GX 270 Honda	HP 8.4 - kW 6.3	270/1	5,3 (5.6)		-	-				103 (227)
	SH178 FA Norwik	HP 5.3 - kW 4	306/1	3,5 (3.6)		-	-				115 (254)
GF 3DF	G 300 FA Loncin	HP 9.3 - kW 6.8	302/1	6,1 (6.4)		✓	✓			123 (271)	
	GX 270 Honda	HP 8.4 - kW 6.3	270/1	5,3 (5.6)		✓	✓			112 (245)	
	SH178 FA Norwik	HP 5.3 - kW 4	306/1	3,5 (3.6)		✓	✓			110 (243)	
											122 (269)
											130 (286)











# GH 8 AGM



										
		HP-kW	CC	L (US qts)		HYDROSTATIC				kg (lb)
<b>GH 8 AGM</b>	G 210 FA Loncin	HP 6-kW 4.4	212/1	3,6 (3.8)		0 - 6 km/h (0 - 3.7 mph)	0 - 3 km/h (0 - 1.9 mph)	20...110 mm (0.78..4,3 in)	58 cm (22.8 in)	135 (297)











# GH 9 AGM



		HP-kW	CC/ 	 L (US qts)						 kg (lb)		
<b>GH 9 AGM</b>	GX 270 Honda	HP 8.4 - kW 6.3	270/1	 5,3 (5.6)		<b>HYDROSTATIC</b>		0 - 6 km/h (0 - 3.7 mph)	0 - 3 km/h (0 - 1.9 mph)	30...110 mm (1.2...4.3 in)	68 cm (26.8 in)	158 (348)









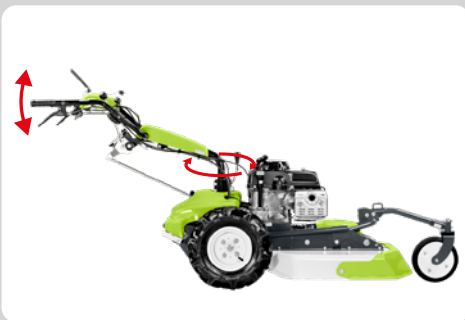

# CL 62M



										
		HP-kW	CC	L (US qts)		HYDROSTATIC				kg (lb)
<b>CL 62M</b>	FJ180V Kawasaki	HP 4.5 - kW 3.4	179/1	1,6 (1.5)		0 - 4,7 km/h (0 - 2.9 mph)	0 - 3 km/h (0 - 1.9 mph)	50...110 mm (2.0...4.3 in)	62 cm (24.4 in)	98 (216)

# CL 75



		HP-kW		 L (US qts)		 DIFF. LOCK					 kg (lb)		
<b>CL 75</b>	GXV 390 Honda	HP 10.2 - kW 7.6	389/1	2,1 (2.2)		✓	<b>HYDROSTATIC</b>		0 - 6 km/h (0 - 3.7 mph)	0 - 3,5 km/h (0 - 2.2 mph)	50...150 mm (2.0...5.9 in)	75 cm (29.5 in)	140 (309)

# CLIMBER 7

## 7.15 - 7.18



CLIMBER 7.18





















CLIMBER 7.18



CLIMBER 7.15



		HP-kW		 L (US qts)	 DIFF. LOCK					 kg (lb)
<b>7.15</b>	LC1P92F Loncin	HP 12 (*15) kW 9.2	452/1	 7 (7.4)		HYDROSTATIC 0 - 9 km/h (0 - 5.6 mph)	 40 cm (15.7 in)	 35...85 mm (1.3...3.3 in)	 85 cm (33.5 in)	250 (551)
<b>7.18</b>	7160 EXi INTEK B&S	HP 15.2 (*18) kW 11.2	656/2	 7 (7.4)		HYDROSTATIC 0 - 9 km/h (0 - 5.6 mph)	 40 cm (15.7 in)	 35...85 mm (1.3...3.3 in)	 85 cm (33.5 in)	255 (562)

\* Gross Power









# CLIMBER 8

## 8.22



KIT MULCHING



		HP-kW		 L (US qts)	 DIFF. LOCK	 HYDROSTATIC			 kg (lb)	
8.22	7220 PXi PROFESSIONAL B&S	HP 18 (*22) kW 13.2	656/2	7 (7.4)	✓	0 - 10 km/h (0 - 6.2 mph)	60 cm (23.6 in)	35...110 mm (1.3...4.3 in)	91 cm (36 in)	290 (639)

# CLIMBER 9

## 9.18 - 9.22s



CLIMBER 9.22s











CLIMBER 9.22s



CLIMBER 9.18



KIT MULCHING

		HP-kW		 L (US qts)						
<b>9.18</b>	7160 EXi INTEK B&S	HP15.2 (*18) kW11.2	656/2	13 (13.7)	✓	HYDROSTATIC 0 - 10 km/h (0 - 6.2 mph)	38 cm (15 in)	30...90 mm (1.2...3.5 in)	91 cm (36 in)	297 (655)
<b>9.22s</b>	7220 PXi PROFESSIONAL B&S	HP18 (*22) kW13.2	656/2	13 (13.7)	✓	HYDROSTATIC 0 - 10 km/h (0 - 6.2 mph)	38 cm (15 in)	30...90 mm (1.2...3.5 in)	91 cm (36 in)	310 (683)

\* Gross Power

# CLIMBER 10

## AWD 27- AWD 23



CLIMBER 10 AWD 23



CLIMBER 10 AWD 27















AWD 27













AWD 23



		HP-kW		 L (US qts)	 DIFF. LOCK	 HYDROSTATIC				 kg (lb)
<b>AWD 23</b>	LC2P77F Loncin	HP22 kW 16	780/2	 13 (13.7)		0 - 9 km/h (0 - 5.6 mph)	76 cm (29.92 in)	35...135 mm (1.4...5.3 in)	93 cm (36.6 in)	350 (772)
<b>AWD 27</b>	8290 CXi COMMERCIAL B&S	HP 22 (*27) kW 16.2	724/2	 13 (13.7)		0 - 9 km/h (0 - 5.6 mph)	76 cm (29.92 in)	35...135 mm (1.4...5.3 in)	98 cm (38.6 in)	385 (849)

# FK 700



										
<b>FK 700</b>	D 722 E4B Kubota	HP 18 kW/13.2	722/3	Diesel 31 (8.1)	✓ DIFF. LOCK	0 - 15 km/h (fast) 0 - 8 km/h (slow)	37 cm (14.5 in)	0...100 mm (0...3.9 in)	115 cm (45.2 in)	615 (1356) kg (lb)

# MD 15-MD 18



MD 15



MD 15



MD 18



MD 18









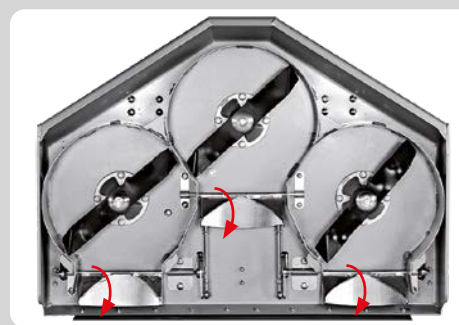

MD 18

		HP-kW								
			CC							kg (lb)
<b>MD 15</b>	LC1P92F Loncin	HP 12 (*15) kW 9.2	452/1		--	<b>HYDROSTATIC</b> 0 - 9 km/h (0 - 5.6 mph)	40 cm (15.74 in)	25...80 mm (0.98...3.14 in)	<b>QUICK SHIFT</b> 83 cm (32.6 in)	235 (518)
<b>MD 18</b>	7160 EXI INTEK B&S	HP 15.2 (*18) kW 11.2	656/2		✓	<b>HYDROSTATIC</b> 0 - 9 km/h (0 - 5.6 mph)	40 cm (15.74 in)	25...80 mm (0.98...3.14 in)	<b>QUICK SHIFT</b> 83 cm (32.6 in)	270 (595.2)

# MD 22N













		HP-kW		 L (US qts)	 DIFF. LOCK	 HYDROSTATIC	 60 cm (23.6 in)	 25...110 mm (0.9...4.3 in)	 QUICK SHIFT	 kg (lb)
<b>MD 22N</b>	7220 PXi PROFESSIONAL B&S	HP 18 (*22) kW 13.2	656/2	7 (7.4)	✓	0 - 10,5 km/h (0 - 6.5 mph)				315 (694)

\* Gross Power

# MD 24 AWD













										
		HP-kW	CC	L (US qts)	DIFF. LOCK	HYDROSTATIC			QUICK SHIFT	kg (lb)
<b>MD 24 AWD</b>	7220 PXi PROFESSIONAL B&S	HP 18 (*22) KW 13.2	656/2	<b>13 (11.8)</b>	✓	0-9 km/h (0 - 5.6 mph)	76 cm (29.92 in)	25...110 mm (0.9...4.3 in)	106 cm (41.7 in)	370 (816)

# MD 28 AWD



MD 28 AWD













										
		HP-kW	CC	L (US qts)	DIFF. LOCK	HYDROSTATIC			QUICK SHIFT	kg (lb)
<b>MD 28 AWD</b>	8290 CXi COMMERCIAL B&S	HP 22 (*27) KW 16.2	724/2	13 (11.8)	✓	0-9 km/h (0 - 5.6 mph)	76 cm (29.92 in)	25...110 mm (0.9...4.3 in)	125 cm (49.2 in)	389 (856)

\* Gross Power

# FX 27

## Zero-Turn













										
		HP-kW	CC	L (US Gal)					kg (lb)	H D W
<b>FX 27</b>	8290 CXi COMMERCIAL B&S	HP 22 (*27) kW 16.2	724/2	<b>30 (7.9)</b>	0 - 12 km/h (0 - 7.4 mph)	<b>ZERO TURN</b>	<b>ELECTRIC</b> 30...85 mm (1.2...3.3 in)	<b>QUICK SHIFT</b> 125 cm (49.2 in)	484 (1067)	H 170 cm D 132 cm W 258 cm

# FD 220E













## Full Electric



											
	MAX POWER	DECK POWER	TRACTION POWER	BATTERY CAPACITY						kg (lb)	H D W
<b>FD 220E</b>	11.7 kW	10 kW	1.7 kW	7.7 kWh	0 - 10 km/h (0 - 6.2 mph)	200 L 5.7 (US bu)	30 cm (11.8 in)	25...90 mm (1.0...3.5 in)	80 cm (31 in)	316 (696.6)	H 114 cm D 86 cm W 234 cm

# FD 220R



		<b>HP-kW</b>		 L (US qts)						 kg (lb)	
<b>FD 220R</b>	LC1P92F Loncin	HP 12 (*15) kW 9.2	452/1	 7 (7.4)	<b>HYDROSTATIC</b> 0 - 9 km/h (0 - 5.6 mph)	200 L 5.7 (US bu)	30 cm (11.8 in)	30...90 mm (1.2...3.5 in)	80 cm (31 in)	263 (580)	H 114 cm D 86 cm W 234 cm
	VANGUARD 16 B&S	HP 14 (*16) kW 10.3	479/2	 7 (7.4)	<b>HYDROSTATIC</b> 0 - 9 km/h (0 - 5.6 mph)	200 L 5.7 (US bu)	30 cm (11.8 in)	30...90 mm (1.2...3.5 in)	80 cm (31 in)	270 (595)	

# FD 280



<b>FD 280</b>	VANGUARD 16 B&S	HP 14 (*16) kW 10.3	479/2	8 (8.4)	✓	HYDROSTATIC	ELECTRIC	30 cm (11.8 in)	30...90 mm (1.2...3.5 in)	113 cm (44 in)	320 (705)	H 120 cm D 119 cm W 238 cm

\* Gross Power

# FD 450



		<b>HP-kW</b>		 L (US Gal)	 DIFF. LOCK	 HYDROSTATIC	 HYDRAULIC	 HYDRAULIC	 ELECTRIC		 kg (lb)	
<b>FD 450</b>	FS600V KAWASAKI	HP 17 kW 12.7.	603/2	 17 (4.5)	✓	0 - 9 km/h (0 - 5.59 mph)	450 L 12.8 (US bu)	30 cm (11.8 in)	25...90 mm (1.0...3.5 in)	113 cm (44 in)	460 (1014)	H <sup>1</sup> 194 cm H 146 cm D 119 cm W 268 cm

# FD 500









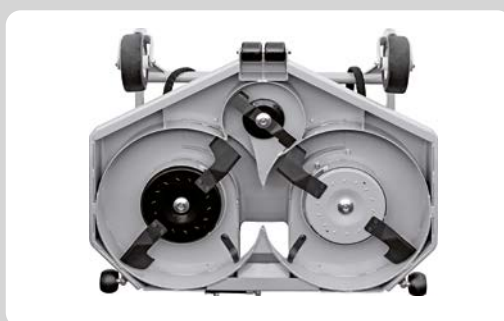



<b>FD 500</b>	D 722 E4B Kubota	HP 18 - kW 13.2	722/3	Diesel 22 (5.8)	✓	0 - 13 km/h (0 - 8 mph)	700 L 19.8 (US bu)	32 cm (12.5 in)	<b>ELECTRIC</b> 25....90 mm (0.9...3.5 in)	113 cm (44.4 in)	610 (1345)	H <sup>1</sup> 193 cm H 151 cm D 119 cm W 271 cm

# FD 900

## 4WD













		HP-kW	CC	 L (US Gal)	 DIFF. LOCK	 HYDROSTATIC	 HYDRAULIC	 HYDRAULIC	 HYDRAULIC		 kg (lb)	
<b>FD 900 4WD</b>	3TNV80F Yanmar	HP 25 - kW 18.4	1267/3	Diesel 31 (8.2)	✓	0 - 15 km/h (0 - 9 mph)	750 L 21.3 (US bu)	37 cm (14.6 in)	20...100 mm (0.8...3.9 in)	126 cm (49.6 in)	980 (2160)	H <sup>1</sup> 207 cm H 166 cm D 133 cm W 291 cm

# FD 13.09

## 4WD













		HP-kW		 L (US Gal)	 DIFF. LOCK						 kg (lb)		
<b>FD 13.09</b> <b>4WD</b>	3TNV82A Yanmar	HP 26 - kW 18.9	1331/3	Diesel <b>23 (6.0)</b>	✓	HYDROSTATIC	HYDRAULIC	HYDRAULIC	HYDRAULIC	20...100 mm (0.8...3.9 in)	132 cm (52 in)	1230 (2712)	H <sup>1</sup> 213 cm H 175 cm D 141 cm W 325 cm
									HYDRAULIC	20...120 mm (0.8...4.7 in)	152 cm (59.8 in)	1310 (2888)	H <sup>1</sup> 213 cm H 175 cm D 162 cm W 340 cm

# FD 2200

## 4WD













		HP-kW		 L (US Gal)	 DIFF. LOCK	 HYDROSTATIC	 HYDRAULIC	 HYDRAULIC			 kg (lb)	
<b>FD 2200 4WD</b>	3TNV88C Yanmar	HP 37 kW 27.5	1642/3	Diesel 50 (13.2)	✓	0 - 20 km/h (0 - 12.4 mph)	1200 L 34 (US bu)	62 cm (24 in)	25...110 mm (0.9...4.3 in)	152 cm (59.8 in)	1490 (3285)	H <sup>+</sup> 243cm H 183 cm D 162 cm W 347 cm

# FD 2200 TS

## 4WD













		HP-kW		 L (US Gal)	 DIFF. LOCK	 HYDROSTATIC	 HYDRAULIC	 HYDRAULIC	 HYDRAULIC	 HYDRAULIC	 kg (lb)	
<b>FD 2200</b> TOP SCORER 4WD	4TNV88C Yanmar	HP 47 kW 34.3	2190/4	Diesel 50 (13.2)	✓	0 - 21 km/h (0 - 13.6 mph)	1400 L 39.7 (US bu)	60 cm (24 in)	20...120 mm (0.8...4.7 in)	152 cm (59.8 in)	1656 (3651)	H <sup>1</sup> 231 cm H 199 cm D 162 cm W 364 cm
										182 cm (71.6 in)		1705 (3758)

# FM 13.09

## 4WD













		HP-kW		 L (US Gal)	 DIFF. LOCK	 HYDROSTATIC		 HYDRAULIC		 LMP	 kg (lb)	
<b>FM 13.09</b> <b>4WD</b>	3TNV82A Yanmar	HP26-kW18.9	1331/3	Diesel 23 (6.0)	✓	0 - 15 km/h (0 - 9.3 mph)	12000 m <sup>2</sup> /h	31 cm (12 in)	20...100 mm (0.8...3.9 in)	160 cm (63 in)	1150 (2535)	H <sup>+</sup> 213 cm H 175 cm D 192 cm W 299 cm

# FM 2200

## 4WD



		HP-kW		 L (US Gal)								
<b>FM 2200</b> <b>4WD</b>	3TNV88C Yanmar	HP 37 kW 27.5	1642/3	Diesel <b>50 (13.2)</b>	✓	<b>HYDROSTATIC</b> 0 - 20 km/h (0 - 12.4 mph)	15500 m <sup>2</sup> /h	<b>HYDRAULIC</b> 62 cm (24 in)	20...90 mm (0.8...3.5 in)	LMP 160 cm (63 in)	1322 (2915)	H <sup>+</sup> 243 cm H 183 cm D 192 cm W 347 cm



Nell'ottica di un costante sviluppo dei propri prodotti, Grillo Spa si riserva il diritto di cambiare le specifiche tecniche e le illustrazioni su questo documento in qualsiasi momento e senza preavviso né obbligo. Foto e caratteristiche non contrattuali. In his pursuit of constant development of his products, Grillo Spa reserves the right to change the technical specifications and the illustrations on this document, at any given moment and without any kind of obligation. All the pictures characteristics are not contract-binding. En poursuivant une politique constante d'amélioration de ses produits, Grillo Spa se réserve le droit de modifier les spécifications techniques en tout temps sans préavis ni obligation. Photographies et caractéristiques non contractuelles. Aufgrund ständiger Weiterentwicklung behält sich Grillo Spa Änderungen in Form, Technik und Ausstattung der Produktpalette vor. Aus Angaben und Abbildungen des vorliegenden Grillo-Katalogs können daher keine Ansprüche abgeleitet werden. En vista de un desarrollo constante de sus productos, Grillo Spa se reserva el derecho de cambiar las especificaciones técnicas y las ilustraciones mostradas en este documento en cualquier momento y sin aviso previo. Las fotos y características no son contractuales.



**Grillo**  
AGRIGARDEN  
MACHINES

www.grillospa.it



grillo@grillospa.it  
Tel. (+39) 0547.633111



GrilloSpa



Grillo SpA



grillo.spa